

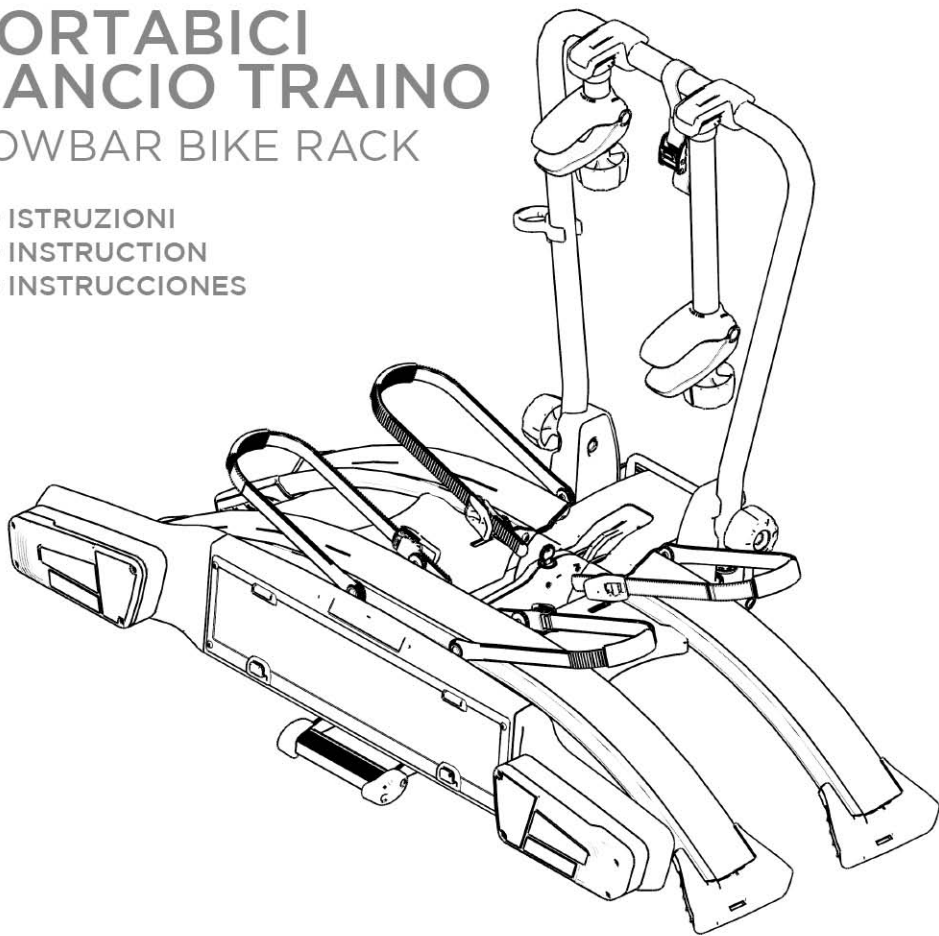

ALTHURA.

PORTABICI GANCIO TRAINO TOWBAR BIKE RACK

- I ISTRUZIONI
- EN INSTRUCTION
- ES INSTRUCCIONES



Art. 1993455 - Alpen E-Bike



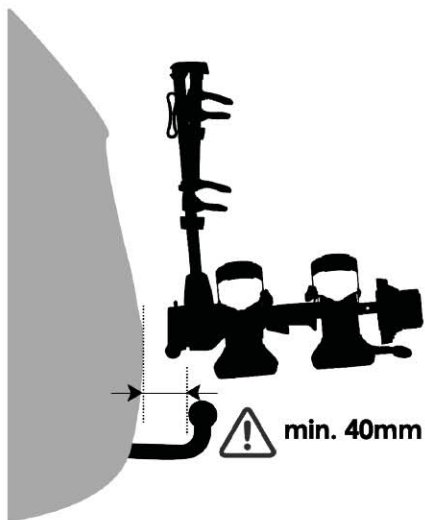
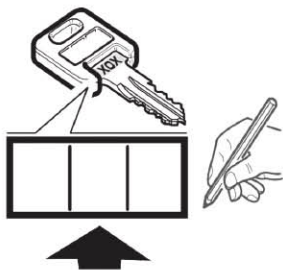

car wash



Not Included



Included

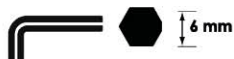

→ 693/CP

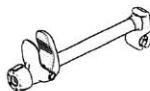

→ 693/MLP

Art. 1993455

x2



Max.60Kg

+

18,2 Kg

\leq

Max. xx Kg

Car Manual

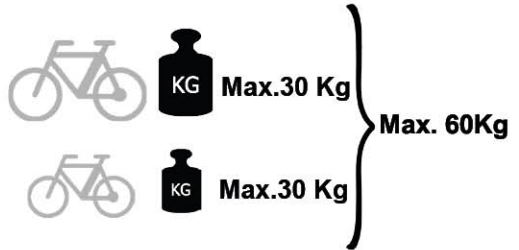
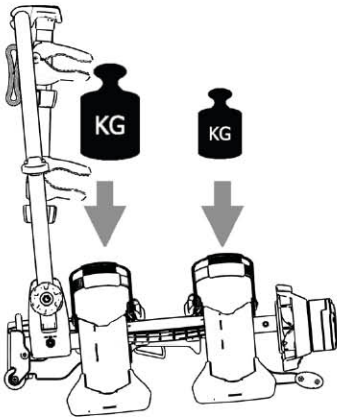

Art. 1993455 = 18,2 Kg

NO



OK



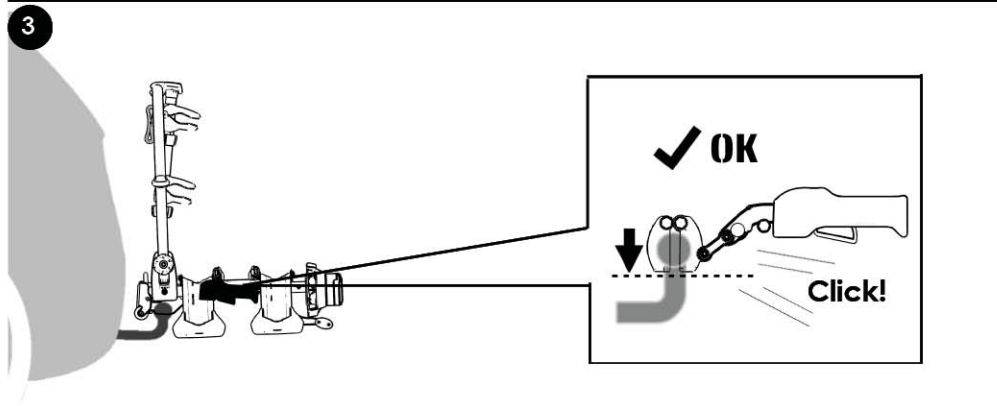
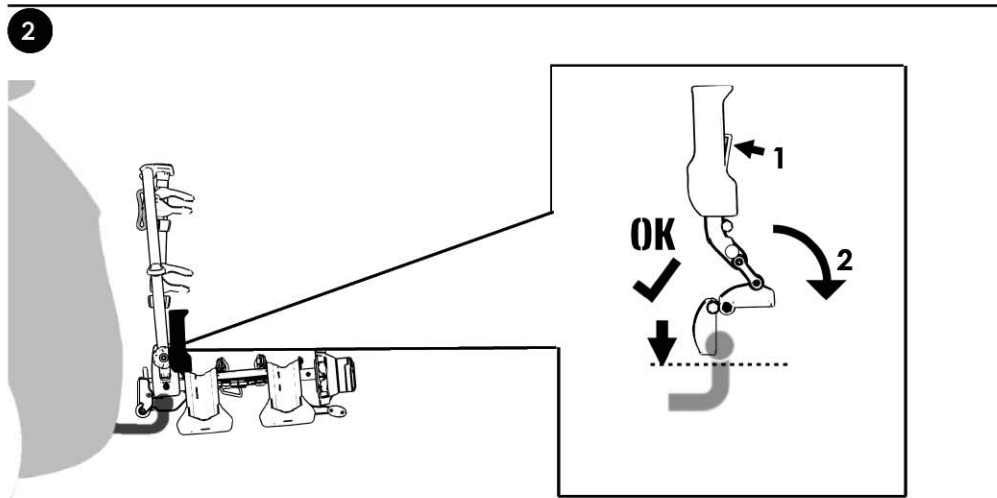
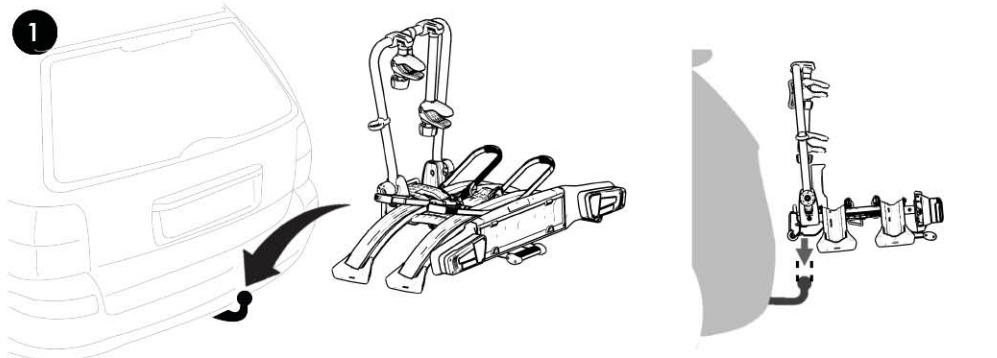

4 **X NOT OK**

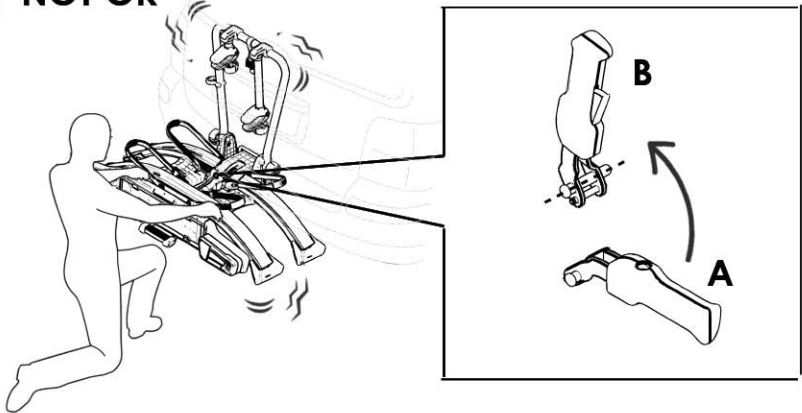

5

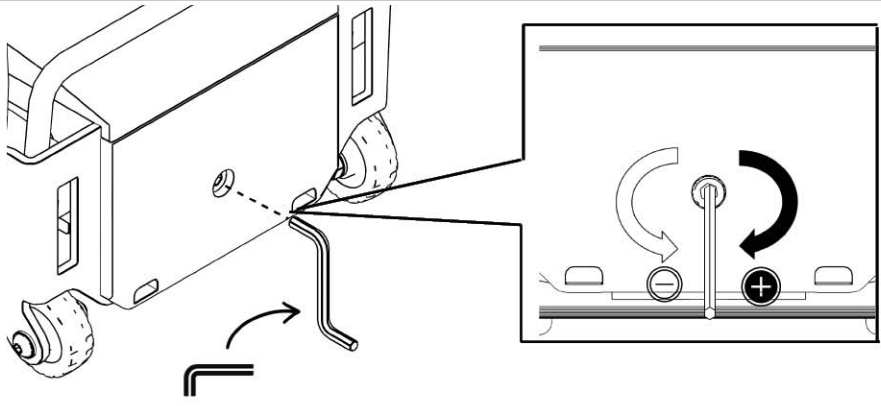

6 **✓ OK**

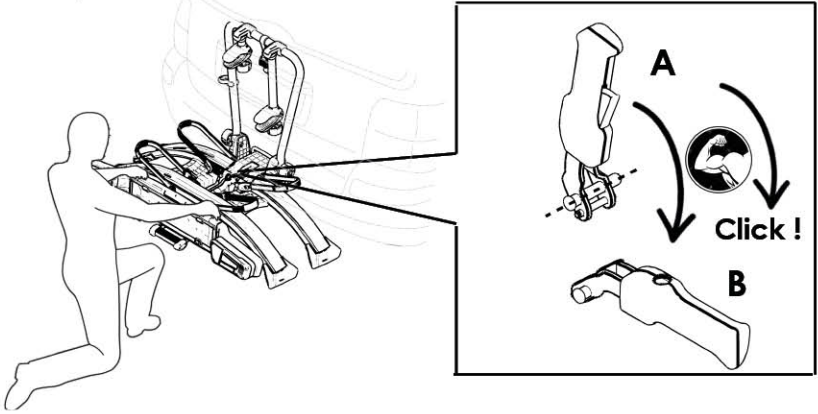

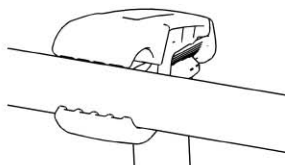
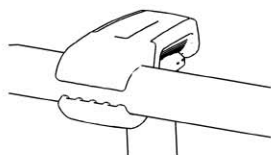
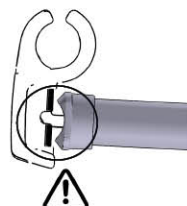
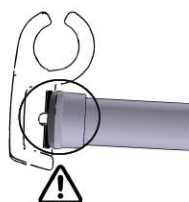
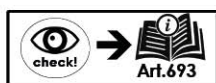
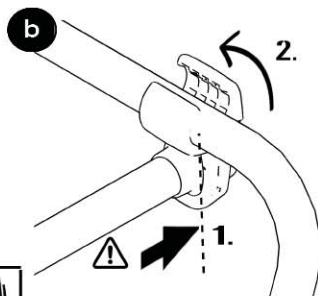
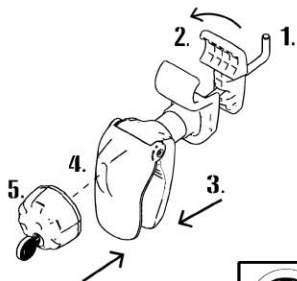
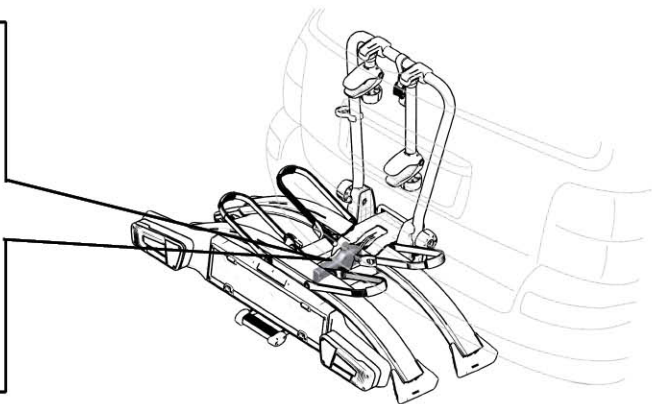
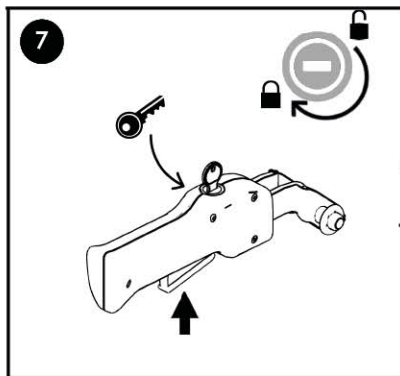

8

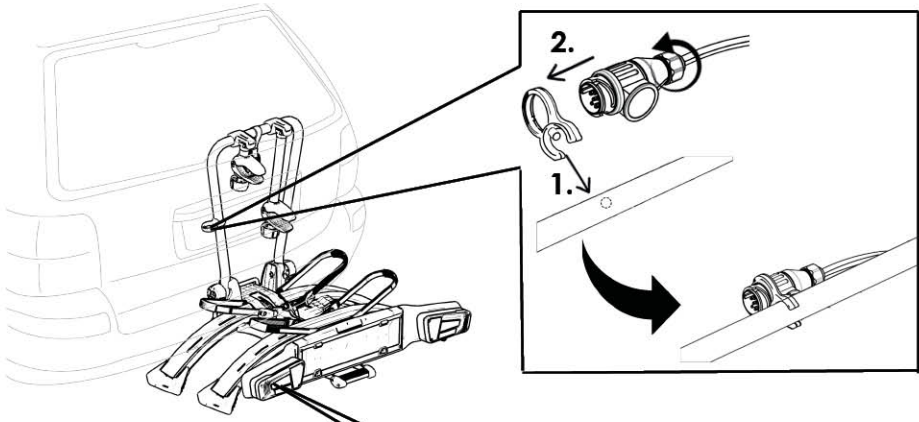

9

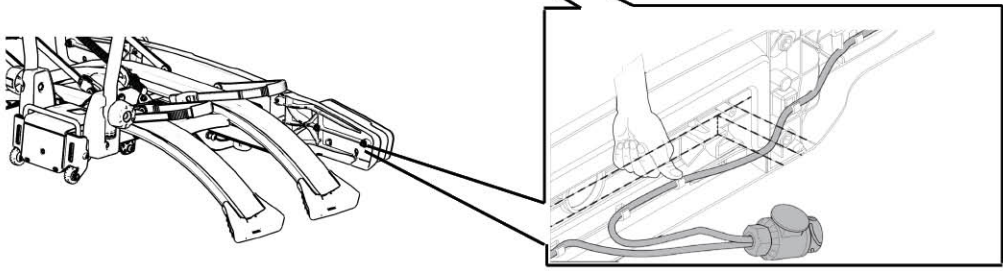

10

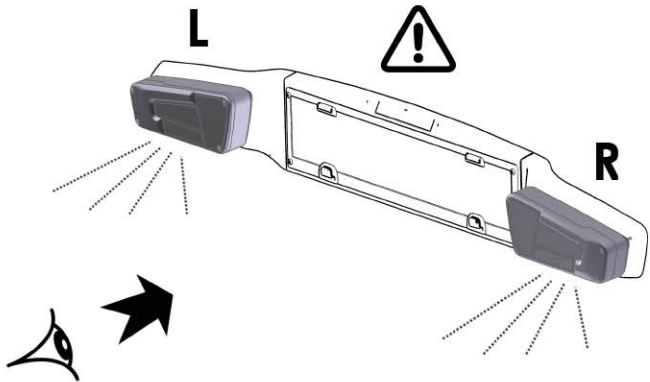

11

✓ OK



✓ OK

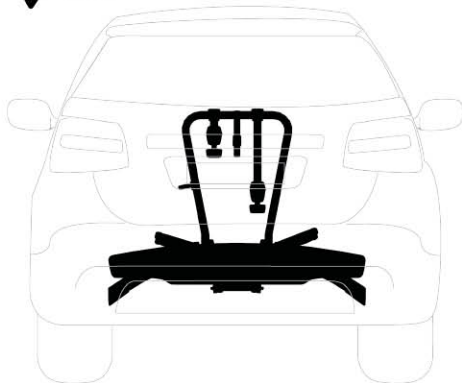

✗ NO

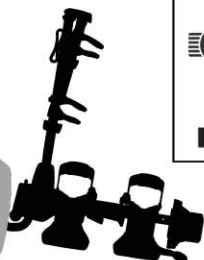

✗ NO



12

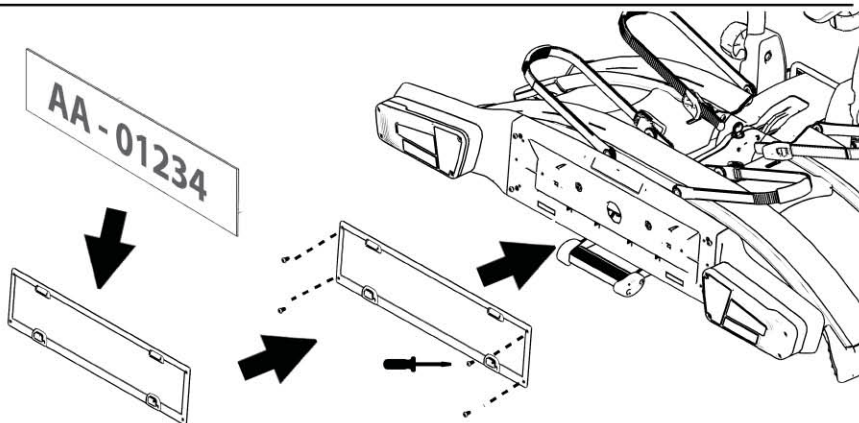

13

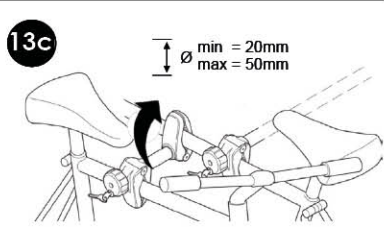
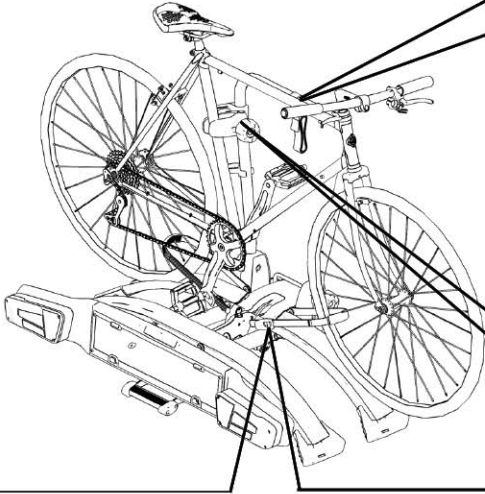
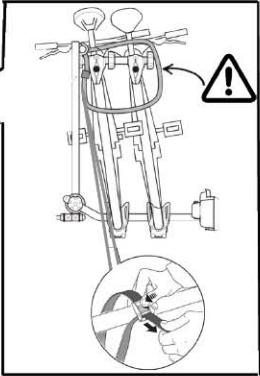

13c

∅ min = 20mm
max = 50mm

13a

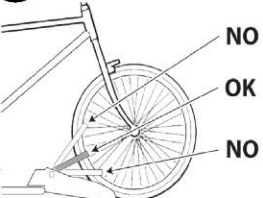

13b

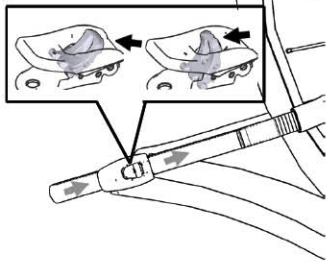
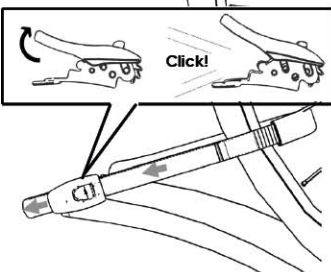

14



Art. 1993455

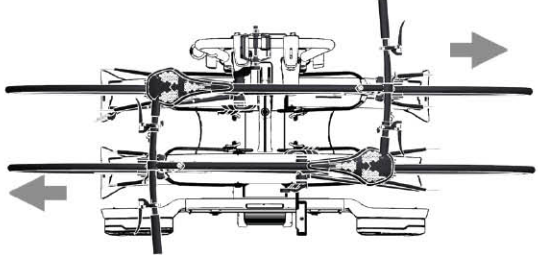

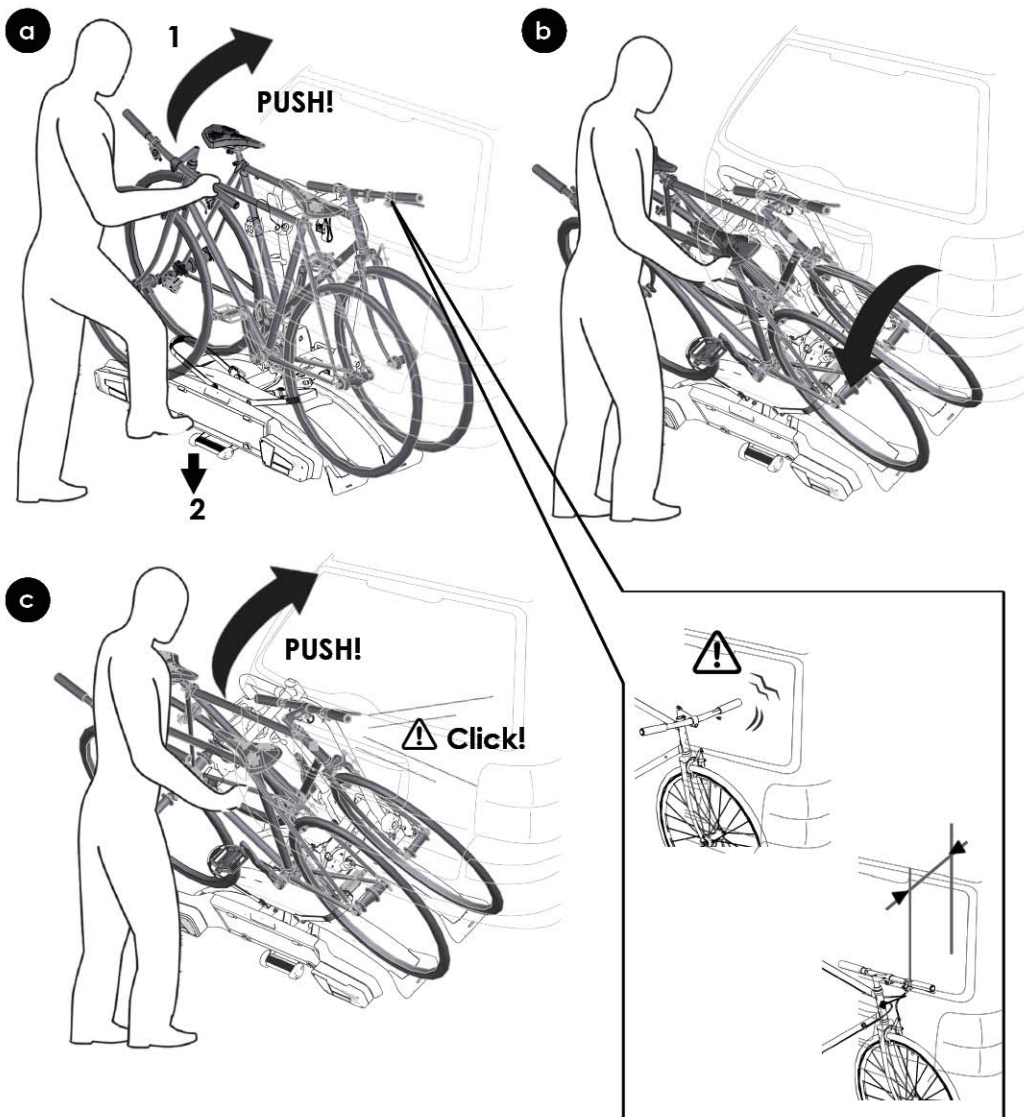
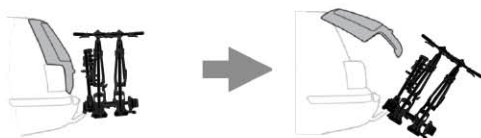

OPTIONALS

**Optional cartello
carico sporgente**
Cod. 1178423



**Optional binario
terza bici max 15kg**
Cod. 2013074

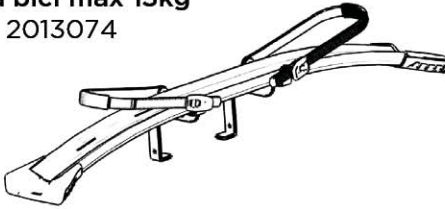

**Optional adattatore
spina 7 > 13 poli**
Cod. 1775942

